

BRACKETS FOR RADIATORS

SUIT / S-PLATT / C-PROLUX / META

S-PLATT / SUIT

In Suit and S-Platt radiators with standard fittings, 4 coloured steel brackets are included in the package.

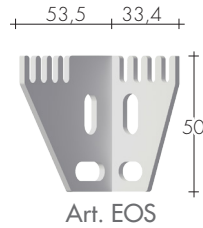

White bracket (each) Art. EOS 7,80€
Bracket in the same colour of the radiator (each) Art. EOSV 10,60€
(package with 2 pieces, right and left)

SPH-PLATT / SUIT H

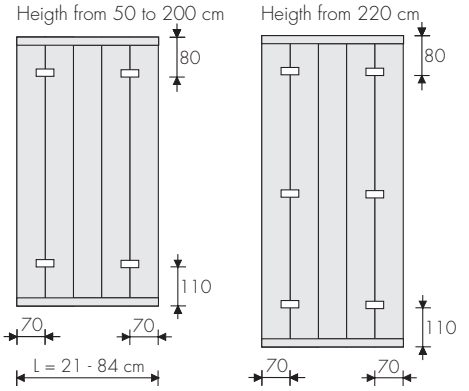
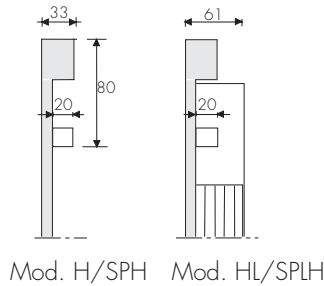
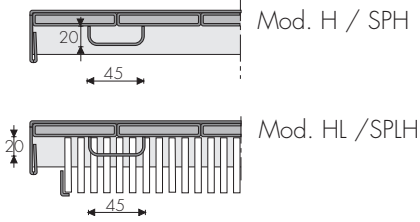

SUIT V / SPV-PLATT

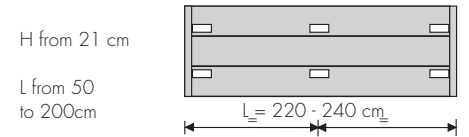
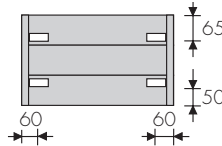
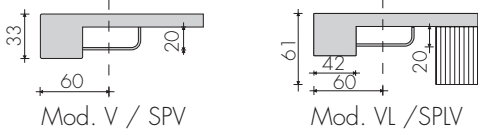

C-PROLUX

In C-Prolux radiators, the brackets and feet in soundproofed plastic are not included in the packaging. The number of brackets and feet varies according to the diagrams provided.

FIXINGS ON WALL

Brackets for convectors are provided on request:

galvanised Art.142 39,00€
white Art.142W 52,20€

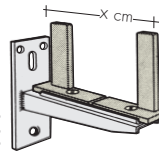

FEET

Adjustable zinc-plated feet and sound-proofed supports:

galvanised Art.150 46,60€
with Art.150W 65,90€
colored Art.150V 76,60€

H = 6,5/9 cm
H = 12/18 cm
H = 18/27 cm
H = 27/37 cm

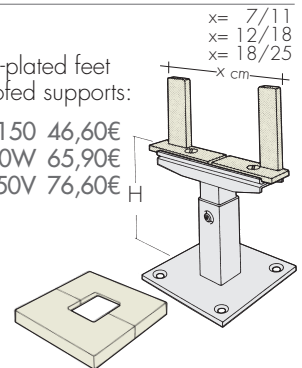

Diagrams for the positions of the feet or brackets for the C-Prolux assembly

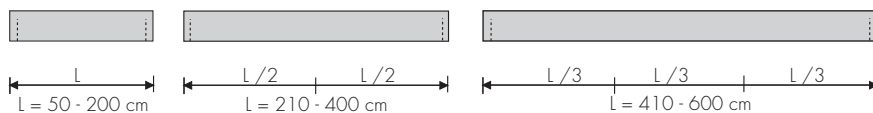

Plastic foot covers (80x80x4mm) are available in white colour only. Art. 156 12,40€

META

META radiators with standard fittings have painted steel brackets included in the package. Request additional brackets for different fittings. (price for each piece)

M.. 1000 white Art. 105W 17,10€
z=50mm colored Art. 105V 22,30€
M5 2000 white Art. 109W 20,50€
z=90mm colored Art. 109V 25,80€
M7 2000 white Art. 111W 22,20€
z=110mm colored Art. 111V 27,20€
(package includes 2 brackets, right and left)

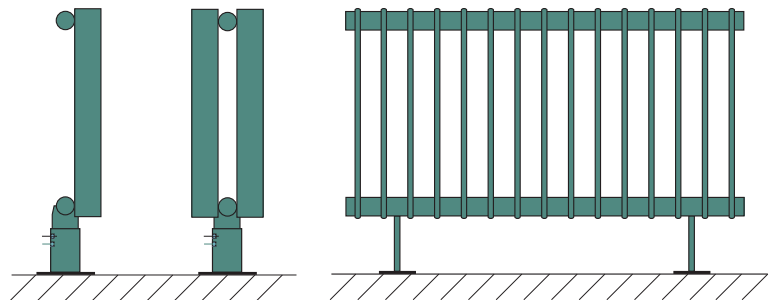
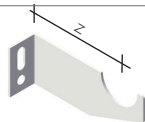

FIXED FOOT (H=15 cm)

The META feet are constructed with the heating element's tube and welded to the same

M 1000 Art. P1N 113,60€
M 2000 (central) Art. P1N 113,60€

ADJUSTABLE FOOT

Standard series foot adjustable from 10 to 15 cm. Feet with made-to-measure heights available on request.

M 1000 Art. P1R 187,50€
M 2000 (central) Art. P1R 187,50€

Length up to 50 cm from 51 to 180 cm

Brackets positions
E.S.: element step
x = E.S.+22,5 mm
y = 2 E.S.+22,5 mm

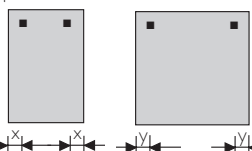

BRACKETS FOR RADIATORS

BREM radiators with standard fittings: depth-adjustable thermoplastic resin wall brackets with an adjustable base (± 4 mm) are included in the supply.

Number:

- 2 brackets for dimensions up to 210 cm
- 4 brackets for greater heights or lengths

■ position of bracket with standard fittings (intermediate positions closed to reinforcements)

□ position of bracket with personalised fittings (ask for extra brackets).

M4 for Form F2, Form UP, Lugal, Cross, Cross-V, Kuadrum

M8 for Cross-Q and Sbarra-UP

M4G for Form F3, Grata

M4F for Form Ondulato, Arco, Curvo and Thun (with angled base)

EOS for Clak, Egon, Open, So-flex

131/151 for Lame, Regular Wind



Art. M4..



Art. M4G..



Art. M4F..



Art. EOS



Art. 131/151

White bracket for white radiator (depth 4 cm)

Art. M4B 11,10€

Art. M4GB 11,10€

Art. M4FB 13,90€

Chrome plated bracket for coloured and chrome-plated radiator (depth 4 cm)

Art. M4C 18,40€

Art. M4GC 18,40€

Art. M4FC 22,40€

BR0019 - BR0033 coloured bracket extra 20,20€

White stainless steel bracket for white radiator (depth 4/6cm)

Art. EOS 7,80€

Art. 131V/Art. 151V 6,90€

Coloured bracket (depth 4/6cm)

Art. EOSV 10,60€

Art. 131V/Art. 151V 10,20€

CROSS-Q/V

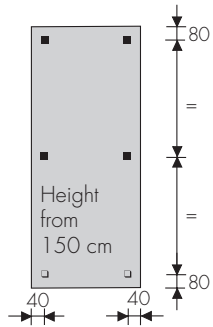
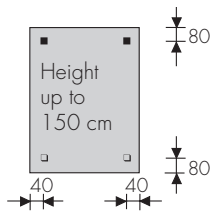

EGON mod. EH

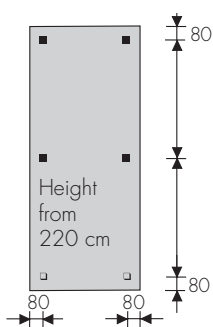
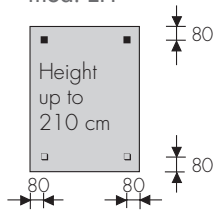

KUADRUM mod. KQH

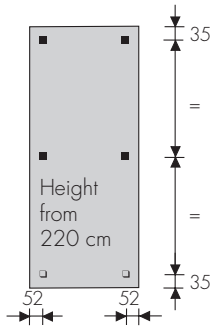
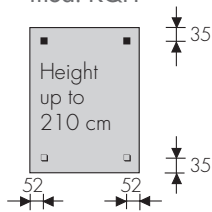

FORM mod. FH

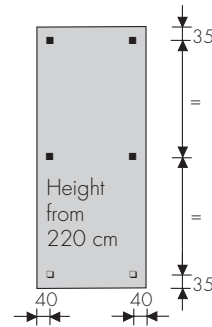
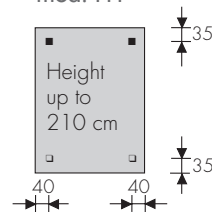

GRATA mod. GRH

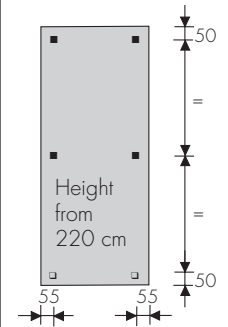
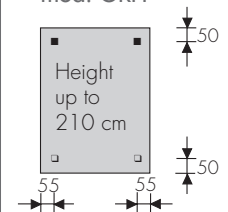

WIND

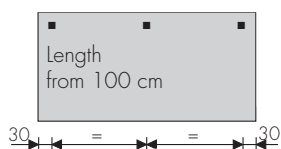
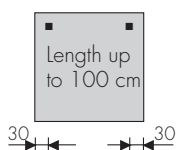

EGON mod. EV

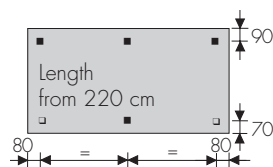
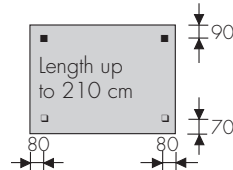

KUADRUM mod. KQV

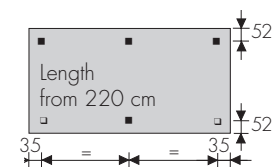
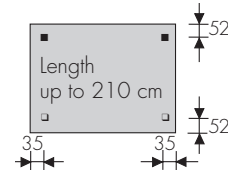

FORM mod. FV

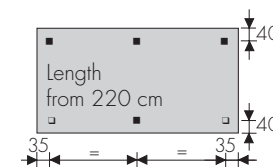
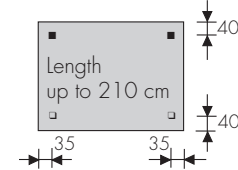

GRATA mod. GRV

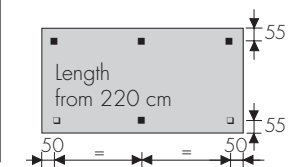
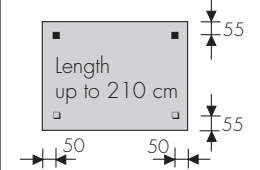

LAME - LAME Slim

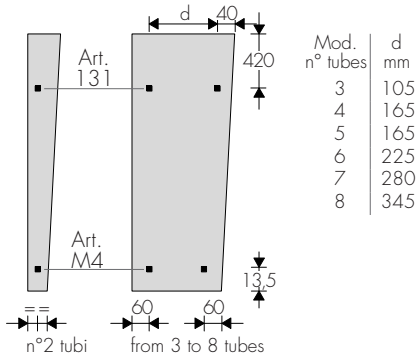

REGULAR step 50

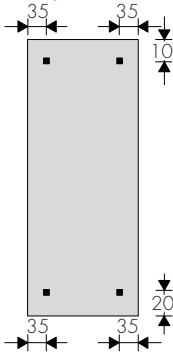

REGULAR step 80

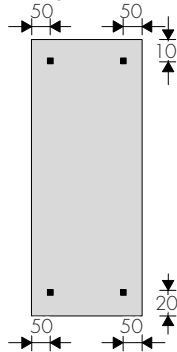

HERG

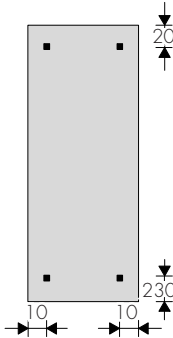

CLAK mod. CKH

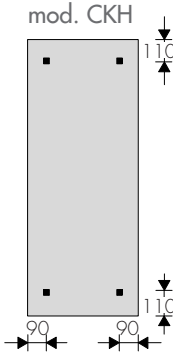

OPEN mod. O..H

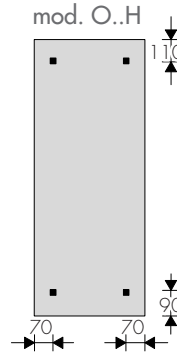

CLAK mod. CKV

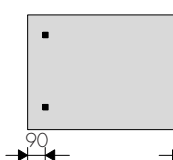

OPEN mod. O..V

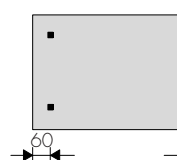

CROSS DIVIS

CROSS DIVIS	H1 cm	H2 cm
164-48	68	56
194-48	48	112
194-48/4	48	120

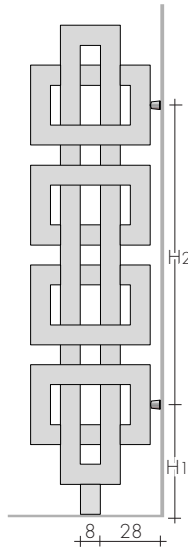

Art. FC4

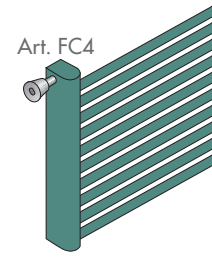

Art. F25

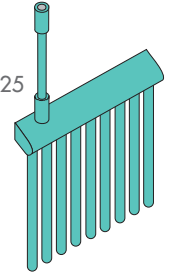

Art. F10

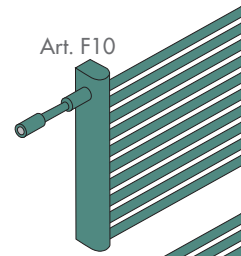

Art. F10

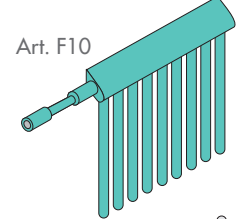

Art. PC...

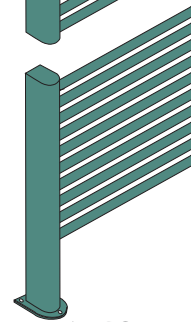

Art. PR..

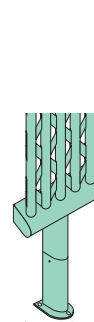

Art. PF..

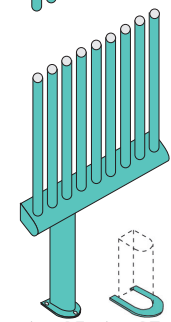

FEET AND FIXINGS

Feet and special fixing supports painted in the final colour, allow radiators and heated towel rails to be used as partitions, providing aesthetically pleasing interior designs.

FIXINGS

Painted side bracket 10 cm (can be reduced to 4 cm) Art. F10 64,80€

Painted ceiling bracket 25 cm (can be reduced to 4 cm) Art. F25 67,60€

Side chrome-plated bracket with sleeve Adjustment: 4/6 cm Art. FC4 55,40€

Bracket FC4 is screwed into sleeve M18 extra charge Art. M18 19,60€

Different length on request.

FEET

Manifold foot H cm 15 Art. PC15 77,40€

H cm 19 Art. PC19 77,40€

Fixed foot standard H cm 15 Art. PF15 70,70€

Adjustable foot standard H cm 15/20 Art. PR15 84,90€

Foot cover (covers the fixing screws) Art. PT.. 28,20€

Made-to-measure length feet, on request.

Foot (15 cm H) with incorporated valve. Art. PV15 150,50€

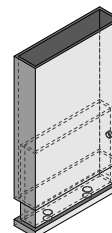

CHROME-PLATED RADIATORS AND HEATED TOWEL RAILS WITH SUPPORTS AND FEET: ON REQUEST

Adjustable foot H 12/15 cm for Cross model Art. PCV12 96,40€
On request, made-to-measure heights